

Operator's Manual

Potato Cutters and Wedger 47703, 47713, 47714, 47715



Learn more about this and other Vollrath products at: Vollrath.com

Register your product at: <http://vollrath.com/Vollrath/Parts-Support/Product-Registration.htm>

Thank you for purchasing this Vollrath Food Processing Equipment. Before operating the equipment, read and familiarize yourself with the following operating and safety instructions. **SAVE THESE INSTRUCTIONS FOR FUTURE REFERENCE.** Save the original box and packaging. Use this packaging to ship the equipment if repairs are needed.

SAFETY PRECAUTIONS

To ensure safe operation, read the following statements and understand their meaning. This manual contains safety precautions which are explained below. Please read carefully.

WARNING

Warning is used to indicate the presence of a hazard that *can* cause severe personal injury, death, or substantial property damage if the warning is ignored.

CAUTION

Caution is used to indicate the presence of a hazard that *will* or *can* cause *minor* personal injury or property damage if the caution is ignored.

NOTE

Note is used to notify people of installation, operation, or maintenance information that is important but not hazard-related.

For Your Safety!

These precautions should be followed at all times. Failure to follow these precautions could result in injury to yourself and others or damage the equipment.

To reduce risk of injury or damage to the equipment:

- Check equipment before each use to insure the equipment is clean.
- Check for broken, nicked or dull blades and if found, replace the blade assembly.
- Check to insure that the pusher head sits down completely on the rubber bumpers.
- Wall mounted equipment must be securely mounted to wall studs. Use proper size and type hardware to mount equipment to wall.
- If necessary, lubricate guide rods using a light coating of mineral oil, Petro Gel, or food grade lubricant. **DO NOT USE COOKING OIL AS IT WILL BECOME STICKY AND MAY PERMANENTLY DAMAGE THE PUSHER HEAD BUSHINGS.**

FUNCTION AND PURPOSE

Intended for cutting, dicing and wedging vegetables and fruits.

UNPACKING THE EQUIPMENT AND INITIAL SETUP

Carefully remove crating or packaging materials from the equipment. When no longer needed, dispose of all packaging materials in an environmentally responsible manner.

1. Use four (4) 1/4" screws of a suitable length to secure the base to the wall. Install screws into studs. If this is not possible, use proper anchors and screws to secure base .

FEATURES AND CONTROLS

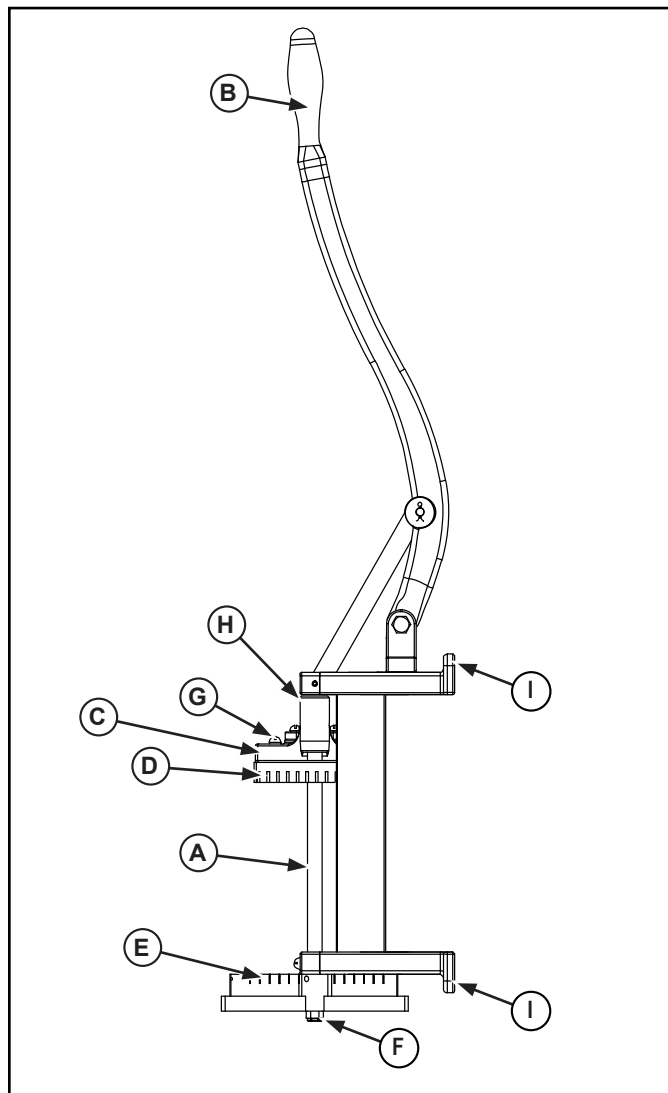



Figure 1. Features and Controls.

- (A) GUIDE RODS. Guides and align the pusher head onto the blade set.
- (B) HANDLE. Used to lower and raise the pusher head block.
- (C) PUSHER HEAD ASSEMBLY. Made up of the pusher head block and blade assembly.
- (D) PUSHER HEAD BLOCK. Pushes the food product through the blade set. Specifically sized to match the corresponding blade assembly.
- (E) BLADE ASSEMBLY. Houses the blades. Specifically sized to match the corresponding pusher head block.
- (F) NUTS, BLADE ASSEMBLY. Used to secure the blade assembly.
- (G) SCREWS, PUSHER BLOCK. Used to secure the pusher block.

- H** COTTER PIN AND PIN. Holds the pusher block to the guide assembly.
- I** MOUNTING HOLES. Used to secure the base.



OPERATION

	 WARNING
	Sharp Blade Hazard. Blades are sharp and can cause cuts. To avoid injury from sharp blades, handle with caution.

Prior to first use, it is important to clean the equipment. Wash new blades with warm soapy water and rinse thoroughly to remove the thin protective oil film. Before each use, check that the equipment is clean and the blades are in good condition and bumpers are in place. If loose or broken blades are found, blades must be serviced.

1. Before each use, always check for proper blade alignment. Slowly set the pusher head (D) onto the blade assembly (E). See Figure 1. They should slide together with no obstructions. If there are obstructions, verify they are a matching set. Remove the obstruction.
2. Verify that the blade assembly and pusher head assembly are the desired size.
3. Prepare the food product to be processed. The maximum size of the food product is 3-1/8" (7.9 cm) in diameter and 6" (15.2 cm) in length.
4. Lift the handle (B) and place the food on the blade assembly (E) with the flat side down.
5. Remove hand from the blade assembly area and place that hand on the leg of the base on table top equipment, or on the wall for wall mounted models.
6. Using a strong, quick, downward thrust, force the food product through the blade assembly.
7. Repeat this process until you have prepared enough food product for your daily needs.
8. Clean and lubricate your equipment immediately after each use. See the **CLEANING** section of this manual for more information.

CLEANING

	 WARNING
	Sharp Blade Hazard. Blades are sharp and can cause cuts. To avoid injury from sharp blades, handle with caution.

To maintain the appearance and increase the service life, clean your daily.

NOTE:

Food acids will make blades dull and corrode the metal. Always clean this food preparation equipment immediately after every use.



1. Remove the screws (G) from the pusher head assembly (C). Remove the pusher head (D). See Figure 1.
2. Remove nuts (F) and carefully remove the blade assembly (E).

3. Wipe, rinse or spray off equipment, pusher head and blade assembly thoroughly with HOT water.
4. Do not wipe across the blades or use scrub pads on this equipment. Wiping across the sharp edge of the blade can cause injury and will dull the blades.
5. The cutting blade assembly is best cleaned by forcing water under pressure through the blades from the unsharpened side. If necessary, use a nylon bristle cleaning brush to push food particles out from the unsharpened side of the cutting blade assembly.
6. Do not put this equipment in a dishwasher or dish machine with soaps, detergents, or other alkaline chemicals that can harm the equipment.
7. After cleaning, let the equipment air dry.
8. Install the blade assembly (E) by setting in place and securing with nuts (F).
9. Install the pusher head assembly by setting the pusher bead in place and securing with the screws (G).
10. Lubricate the guide rods (A) with mineral oil or Petro Gel after each use. Do not use cooking oil as it will become sticky and may permanently damage the equipment.

PREVENTATIVE MAINTENANCE

1. Clean the equipment after every use.
2. Use for intended purposes only.
3. Change the blades regularly - based on usage.

REPLACING BLADE ASSEMBLY

	 WARNING
	Sharp Blade Hazard. Blades are sharp and can cause cuts. To avoid injury from sharp blades, handle with caution.

Wash new blades with warm, soapy water and rinse thoroughly to remove the thin protective oil film. Keep the sharp edge away from you when handling blades.

1. Remove the screws (G) from the pusher head assembly (C). Remove the pusher head (D). See Figure 1.
2. Remove nuts (F) and carefully remove the blade assembly (E).
3. Install the blade assembly (E) by setting in place and securing with nuts (F).
1. Slowly set the pusher head (D) onto the blade assembly (E). S They should slide together with no obstructions. If there are obstructions, verify they are a matching set. Remove the obstruction.
2. Lubricate the guide bar with mineral oil or Petro Gel after each use. Do not use cooking oil as it will become sticky and may permanently damage the equipment.

ENGLISH

TROUBLESHOOTING

If the equipment no longer processes food cleanly or without damage to the food product, the blades could be dull and be in need of replacement. Broken, bent, or nicked blades must be replaced.

Problem	It might be caused by	Course of Action
Broken Blade.	Blades were dull.	Pre-score whenever possible to avoid undue shock and stress to blades. Replace the blade assembly.

SERVICE AND REPAIR

Please contact the qualified professional repair service listed below.

VOLLRATH Induction Repair Service • 1-800-825-6036 (USA) or www.vollrathco.com

When contacting the Authorized Professional Service Center, please be ready with the model number, serial number, and proof of purchase showing the date the equipment was purchased.

To learn more about potato cutters and wedgers and accessories or parts visit:

<http://vollrath.com/ProductFamily/Food-Preparation-Equipment/French-Fry-Potato-Cutter.htm>

WARRANTY STATEMENT FOR THE VOLLRATH Co. L.L.C.

The Vollrath Company LLC warrants the products it manufactures and distributes against defects in materials and workmanship for a period of one year, except as specifically provided below. The warranty runs 12 months from the date of original installation. (End user receipt)

1. Refrigeration compressors – The warranty period is 5 years.
2. Refrigerated Display Cases (RDE) compressors the warranty is 3 years.
3. Replacement parts – The warranty period is 90 days.
4. Aluminum Fry pans are 90 days.
5. EverTite™ Riveting System – The warranty covers loose rivets only, lifetime to original purchaser.
6. Cayenne® Heat Strips – The warranty period is 1 year plus an additional 1 year period on heating element parts only.
7. Ultra, Ultra Fajita, Mirage® Pro and Professional Induction Ranges – The warranty period is 2 years.
8. Mirage®, Mirage® Cadet, Mirage® Fajita and Commercial Induction ranges - The warranty period is 1 year.
9. ServeWell® Induction Workstations – The warranty period is 1 year on the workstation table and 2 years on induction hobs.
10. Slicers – The warranty period is 10 years on gears and 5 years on belts.
11. Mixers – The warranty period is 2 yrs parts, 1 yr labor and belts are 5 years.
12. Vollrath – Redco products – The warranty period is 2 years.
13. Optio / Arkadia product lines – The warranty period is 90 days.
14. All non-stick products (i.e. fry pans and surfaces) are 90 days for the non stick surfaces.
15. All TRAEX® product warranty (with the exception of T-REX™) is 1 year.
16. T-REX™ product by TRAEX® is lifetime warranty.

All products in the Jacob's Pride® collection, including the following, have a lifetime warranty:

- NSF Certified One-Piece Dishers
- NSF Certified Spoodle® Utensils
- NSF Certified Heavy-Duty Spoons with Ergonomic Handle
- NSF Certified Heavy-Duty Basting Spoons
- Heavy duty Turners with Ergonomic handle
- One-Piece Tongs*
- Heavy-Duty One-Piece Ladles*
- Nylon Handle Whips
- One-Piece Skimmers
- Tribute®, Intrigue®, and Classic Select® Cookware*

*Jacob's Pride® warranty does not cover Kool-Touch®, non stick coatings and silicone handles.

All Miramar® Cookware listed below has a lifetime warranty.

- Casseroles Pans
- Oval Pans
- Sauté Pans
- French Omelet Pans
- Brazier Pans
- Stir Fry Pans
- Stir Fry Server
- Sauce Pans
- Small / Large food Pans
- French Oven
- High/Low Dome Covers

Note: Miramar® warranty does not include Buffet, Table Top Service, Templates, Decorative pans, or soup inserts

THIS WARRANTY IS IN LIEU OF ANY OTHER WARRANTIES, EXPRESS OR IMPLIED, INCLUDING ANY IMPLIED WARRANTY OF MERCHANTABILITY OR FITNESS FOR A PARTICULAR PURPOSE

As The Vollrath Company LLC's only responsibility and the purchaser's only remedy, for any breach of warranty, The Vollrath Company LLC will repair or, at its option, replace the defective product or part without charge, except as otherwise provided below:

- For refrigeration compressors and the second year of the warranty on Cayenne® Heat Strips and mixers, The Vollrath Company LLC will provide the repaired or replacement part only; and the buyer will be responsible for all labor charges incurred in performing the repair or replacement.
- To obtain warranty service, the buyer will be responsible to return to The Vollrath Company LLC any product (other than gas equipment that is permanently installed) weighing less than 110 lbs. or located outside of a 50-mile radius of a certified technician designated by The Vollrath Company LLC to perform warranty repairs. If a Vollrath Technician cannot be contacted check the website for service contact points. (Please refer to the Product Catalogue for weights and sizes of product)
- No remedy will be available for products that have been damaged by accident, carelessness, improper installation, lack of proper setup or supervision when required, neglect, improper use, installation or operation contrary to installation and operating instructions or other causes not arising out of defects in materials or workmanship. At the buyer's request, The Vollrath Company LLC will repair and or replace such products at a reasonable cost.
- No remedy will be available for slicers where blade has not been sharpened (Refer to owner's manual for sharpening instructions)
- No remedy will be available for mixers damaged by changing gears while equipment is running or overloading, in either case as determined by a Vollrath Certified Technician
- Warranty work must be authorized in advance by The Vollrath Company LLC. See the operating and safety instructions for each product for detailed warranty claim procedures.
- No remedy will be available for product returned and found to be acceptable to the product specification.
- No remedy will be available under any warranty not registered as required below.

Items Not Covered Under Warranty:

- Meat Grinder Knives
- Light Bulbs in Convection Ovens, Hot Food Merchandiser and displays, Heat Lamps, and Heat Strips
- Oven Door Seals
- Oven Door Glass, Breath Guard Glass
- Hot Food Merchandisers / Display Case Glass
- Calibration and set up of gas equipment
- Manual Slicer / Dicer blades (table top food prep) – Redco and Vollrath

LIMITATION OF LIABILITY:

THE VOLLRATH COMPANY LLC SHALL HAVE NO LIABILITY FOR INCIDENTAL OR CONSEQUENTIAL DAMAGES OF ANY KIND, WHETHER BASED UPON NEGLIGENCE OR OTHER TORT, BREACH OF WARRANTY, OR ANY OTHER THEORY.

ENGLISH

WARRANTY PROCEDURE

On all warranty calls, the following process and information is required:

- All warranty claims will start with a call to Vollrath Technical Service support line. (800-628-0832).
- A technical support professional will work to diagnose the issues, and provide the details for the service solution.
- Name and phone number of person calling
- Business name, street address, city, state and zip
- Model and serial number
- Date of purchase and proof of purchase (Receipt)
- Name of dealer where unit was purchased

NOTE: Vollrath will not accept products sent without the proper procedure being followed.

Important:

TO MAKE A CLAIM FOR ANY REMEDY UNDER THIS WARRANTY, YOU MUST REGISTER YOUR WARRANTY.

REGISTER TODAY

ONLINE: Register your warranty on-line now at www.Vollrathco.com

NO WEB ACCESS: If you do not have access to the web, kindly register by completing the warranty registration form and faxing it to The Vollrath Co. LLC office in the country of purchase.

WARRANTY REGISTRATION			
BUSINESS NAME			
KEY CONTACT NAME		EMAIL	
STREET ADDRESS			
CITY	STATE	ZIP CODE	
COUNTRY	PHONE	FAX	
MODEL		ITEM NUMBER	
SERIAL NUMBER	-	-	-
OPERATION TYPE			
<input type="checkbox"/> Limited Service Restaurant	<input type="checkbox"/> Full Service Restaurant	<input type="checkbox"/> Bars and Taverns	<input type="checkbox"/> Supermarket
<input type="checkbox"/> Convenience Store	<input type="checkbox"/> Recreation	<input type="checkbox"/> Hotel/Lodging	<input type="checkbox"/> Airlines
<input type="checkbox"/> Business/Industry	<input type="checkbox"/> Primary/Secondary School	<input type="checkbox"/> Colleges/University	<input type="checkbox"/> Hospitals
<input type="checkbox"/> Long-Term Care	<input type="checkbox"/> Senior Living	<input type="checkbox"/> Military	<input type="checkbox"/> Corrections
REASON FOR SELECTING OUR PRODUCT			
<input type="checkbox"/> Appearance	<input type="checkbox"/> Full Service Restaurant	<input type="checkbox"/> Availability	<input type="checkbox"/> Sellers Recommendation
<input type="checkbox"/> Ease of Operation	<input type="checkbox"/> Versatility of Use	<input type="checkbox"/> Price	<input type="checkbox"/> Brand
WOULD YOU LIKE TO RECEIVE OUR FULL-LINE CATALOG AND REMAIN ON OUR MAILING LIST?			<input type="checkbox"/> Yes <input type="checkbox"/> No



www.vollrathco.com

The Vollrath Company, L.L.C.
1236 North 18th Street
Sheboygan, WI 53081-3201
U.S.A.

Main Tel: 920.547.4851
Fax: 800.752.5620

Technical Services: 800.628.0832
Service Fax: 920.459.5462

Canada Service: 800.695.8560

© 2013 The Vollrath Company, L.L.C.