

Operators Manual

Use and Care Instructions Electric Models, SteamCraft Ultra 3, 5, 10



Series: 21CET8, 21CET16, 24CEA10

1333 East 179th Street
Cleveland, Ohio 44110

Phone: (216) 481-4900
Fax: (216) 481 3782



Cleveland

FOR THE USER

⚠ WARNING

Improper installation, adjustment, alterations, services or maintenance can cause property damage, injury or death. Read the installation, operating and maintenance instructions thoroughly before installing or servicing this equipment.

⚠ WARNING

Disconnect power before servicing

IMPORTANT

A QUALIFIED CLEVELAND RANGE TECHNICIAN MUST PERFORM ALL SERVICE.

RETAIN THIS MANUAL FOR YOUR REFERENCE

You may wish to record the following items for future use.

Model Number _____

Serial Number _____

Date of Installation _____

OPERATOR'S MANUAL

Table of Contents

Chapter	Page
SECTION 1: INTRODUCTION	1
A. OPERATIONAL SAFETY	1
B. PRODUCT INFORMATION	2
(1) Serial Number	2
(2) Model Number	2
(3) Product information Plate	2
C. PRODUCT DESCRIPTION	3
SECTION 2: COMPARTMENT CONTROL PANELS	4
A. DIAL TIMER CONTROL PANEL	4
(1) Cooking Operations – Dial Timer Control Panel	4
(2) Manual and Timed Mode	4
a. Manual Mode	4
b. Timed Mode	4
B. KEYPAD TIMER CONTROL PANEL	5
(1) Cooking Operations – Keypad Control Panel	5
(2) Manual and Timed Modes	5
a. Manual Mode	5
b. Timed Mode and Use of the Timer	5
SECTION 3: GENERAL OPERATION	7
A. EXTERNAL MAIN POWER SWITCH	7
B. DOOR INTERLOCK SWITCH (Optional)	7
C. POWER ON (AUTOMATIC FILL)	7
D. INSPECTING THE COOKING COMPARTMENT	8
E. PREHEATING THE STEAMER	8
F. DESCALING REQUIRED LIGHT FEATURE	8
SECTION 4: COOKING WITH THE STEAMER	9
A. OPERATING AND COOKING PROCEDURE – TIMED MODE	9
B. OPERATING AND COOKING PROCEDURE – MANUAL MODE	10
(1) Using the Timer in Manual Mode	10
(2) Manual Cooking Procedure	10
SECTION 5: SHUTDOWN AND CLEANING PROCEDURES	11
A. STEAM GENERATOR BLOWDOWN	11
(1) Power Off (Automatic Blowdown)	11
(2) Blowdown Frequency	11
(3) Blowdown Procedure	12
B. SHUTDOWN AND CLEANING	12
SECTION 6: PREVENTATIVE MAINTENANCE AND TROUBLESHOOTING	14
A. MAINTENANCE	14
(1) Maintenance Records	14
(2) Daily Maintenance	14
(3) Weekly Maintenance	14
(4) Weekly/Monthly Maintenance Descale Steam Generator	16
B. OPERATOR'S TROUBLESHOOTING GUIDE	17

(Continued on Next Page)

(Table of Contents Continued)

SECTION 7: STEAM COOKING GUIDELINES	21
A. INTRODUCTION	21
B. SIZING UP PAN CAPACITY	22
(1) Serving Sizes – How Much? How Many?	22
(2) Reference Charts for Typical Pan Capacities	22
C. CONVECTION STEAMER – SUGGESTED TIMER SETTING GUIDELINES	23
D. STEAMING TIPS -LOBSTER -CRAB -SHRIMP	25
(1) Live lobsters and Crabs	25
(2) Lobster Tail 8 oz.	25
(3) King Crab Legs	25
(4) Shrimp	25
SECTION 8: LIMITED WARRANTY	26

SECTION 1: INTRODUCTION

To use a SteamCraft Convection Steamer safely and effectively, each operator must read and understand this Manual completely before starting operation. The owners and operators of the steamer should retain this Manual in an easily accessible location for future reference and training.

The owner(s) and operator(s) of the steamer must be aware that steam can cause serious injuries and equipment damage. Pay particular attention to the Operational Safety section of this chapter, and the WARNINGS and CAUTIONS displayed in this manual and on the equipment.

 WARNING
DO NOT ATTEMPT TO START OR OPERATE a SteamCraft steamer during a power outage. DEATH, INJURY, AND EQUIPMENT DAMAGE could result from the improper installation of a steamer. Before starting a recently installed or repaired steamer, be sure it has been installed by qualified personnel according to the instructions found in the separate Installation and Maintenance Manual.

A. OPERATIONAL SAFETY

The safe and effective operation of any steamer depends upon proper installation, use, maintenance, and repair. Operational safety must encompass all of these factors. This Operational Safety section outlines the minimum safety policies that should be considered when using one or more SteamCraft steamers. It is assumed that any operational safety program must be tailored to the specific site and use of the equipment.

Burn hazards are present in any professional food service operation. When using the steamer, observe the following precautions.

- Remember at all times that steam can cause severe burns.
- When checking inside the steamer always open the door slowly and stand to the side and back away from the steamer. Water leaking from the door gasket can be a sign of a blocked drain. If the drain is blocked, hot water can accumulate inside the compartment and spill out when the door is opened.
- Make sure the compartment is turned OFF. Open the door slightly to allow steam to vent before looking or reaching into cooking compartment.
- Do not reach into the cooking compartment until the steam has cleared.
- Do not reach into steamer or handle hot items without wearing heatproof gloves. Wet or damp gloves conduct heat, and may cause burns when touching hot items.
- Do not use anything but your hands to operate the ON/OFF controls.
- Do not block the vents on the side, rear or underside of the unit or otherwise obstruct the flow of ventilation air to the steamer. Do not store articles on top of the unit.

The steamer requires a minimum of service if properly operated and maintained by trained personnel. The following steps will help keep the steamer in a safe, efficient operating condition.

- (1) Do not store or leave combustible materials near the steamer. Keep the area around and under the steamer free of combustible materials.
- (2) Non slip draining mats should be on the floor in front of the steamer to prevent slipping accidents from spilled water.

- (3) Train all personnel who will use the steamer. Make sure personnel know how to operate the steamer, clean the interior and exterior, drain the unit, and descale the steam generator.
- (4) Operating personnel must be able to recognize problems, and report them so that corrective actions can be taken by trained personnel as outlined in the troubleshooting charts found in the back of this manual and in the separate Installation and Maintenance Manual.
- (5) Conduct regular steamer inspections. Check for water line leaks, door seal and drain leaks, clogged drain, steam generator scale buildup, and steamer control malfunctions.
- (6) Follow the instructions for steamer maintenance found in this manual and the additional literature provided with the steamer.
- (7) Before each use of the steamer, inspect the drain and screen for blockage. Inspect the door gasket assembly, and slide racks for proper installation and cleanliness.
- (8) Allow only Cleveland Range authorized service representatives to service the steamer.
- (9) Use only factory authorized repair parts.
- (10) Maintain written records of steamer maintenance and service. Each record should include at least:
 - The date of the service or maintenance.
 - A description of the service, maintenance or repair performed. Include part numbers if applicable.
 - Copies of purchase order(s) and invoice(s) for repair parts and service.
 - The name and signature of the person performing the maintenance or service.

B. Product Information

(1) Serial Number

The Serial number is located at the back of the unit. During manufacture, SteamCraft Steamers are assigned individual serial numbers. Whenever any inquiry is made with Cleveland Range regarding a steamer the serial number should be referenced.

(2) Model Number

This manual covers model numbers 21CET8, 21CET16 and 21CEA10.

(3) Product Information Plate

The Product Information Plate located on the rear (Model 21CET8 and 21CET16) or the left side (Model 24CEA10) of the unit lists the model and serial number as well as the power supply and the wiring requirements of the steamer.

C. Product Description

Models 21CET8, 21CET16

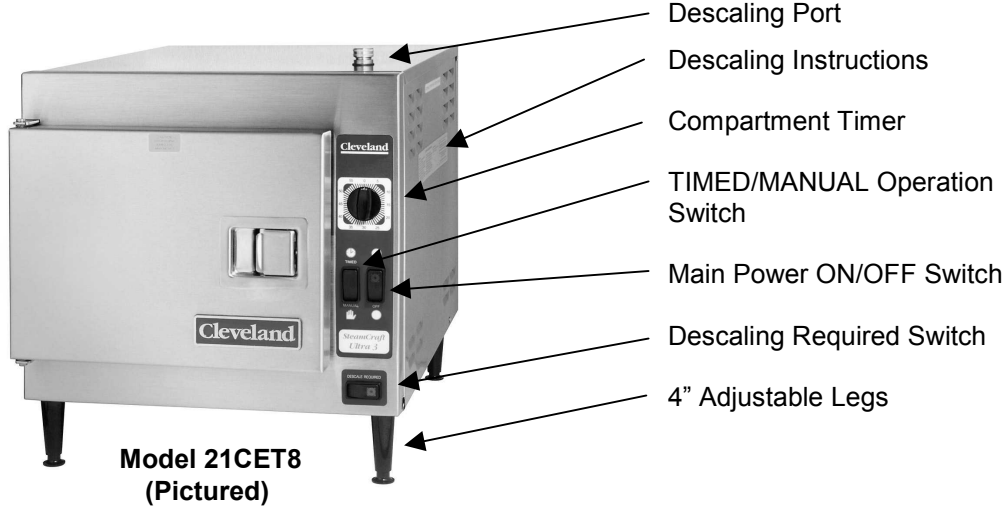

Model 24CEA10

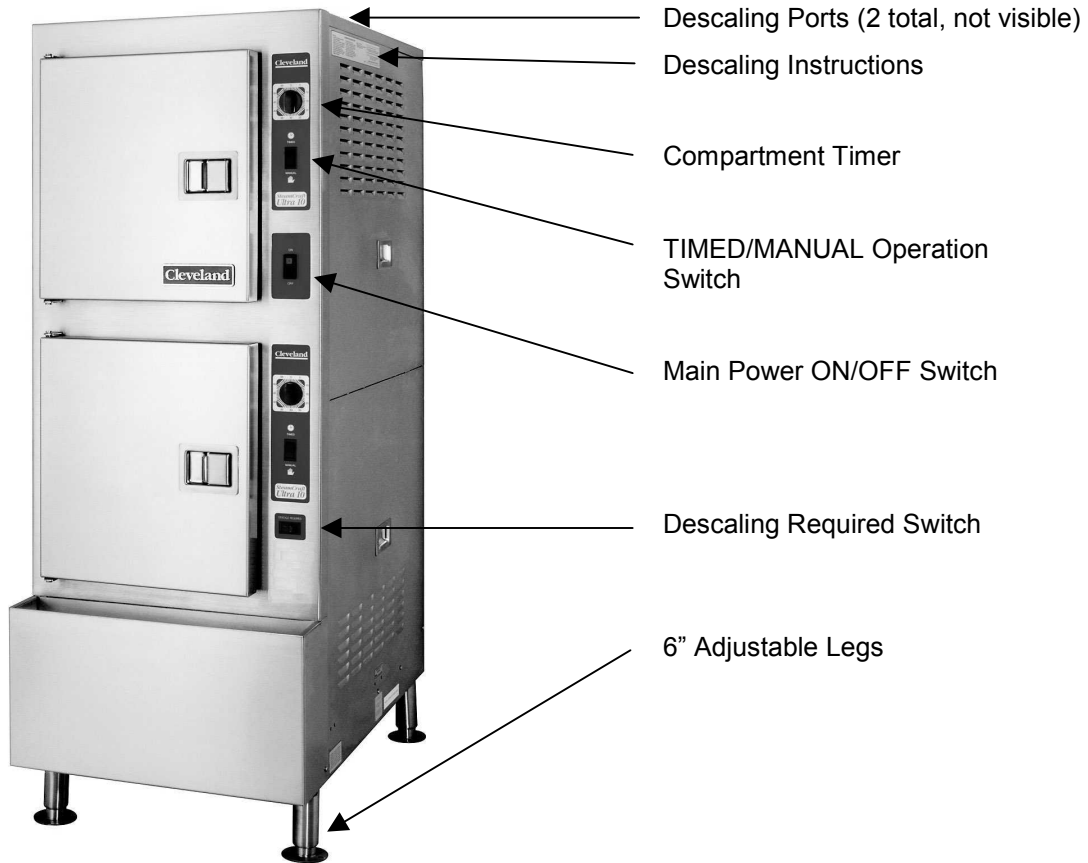

SECTION 2: COMPARTMENT CONTROL PANELS

The standard steamer control panel, illustrated in Figure 2-1 has a mechanical timer. An optional electronic keypad timer illustrated in Figure 2-2 of SECTION 2, Part B and an ON/OFF control panel are also available. The Electronic timer uses a temperature compensation circuit, which allows the timer to count down only while the cooking compartment is at cooking temperature. The ON/OFF Control Panel, which is not illustrated, operates exactly like the manual operation of the timed models except a selector switch is used to turn the steam to the cooking compartments ON and OFF.

A. DIAL TIMER CONTROL PANEL

(1) Cooking Operations – Dial Timer Control Panel

For safe, efficient operation of the steamer, the operator must, at a minimum, comply with all cautions, warnings and instructions in the detailed operating procedures and be familiar with the control panel shown in Figure 2-1. The operator must be familiar with all the operating features explained in this manual before attempting to operate the steamer.

(2) Manual and Timed Modes

The steamer has two operating modes: manual and timed. The TIMED/MANUAL rocker switch selects the operating mode. Pressing the MANUAL end of the switch selects the manual-operating mode. Pressing the TIMED end of the switch selects the timed operating mode. Cooking procedures are slightly different for each mode.

a. Manual Mode

The manual mode provides continuous steaming. The operator starts and stops steaming operations manually. See the Operating and Cooking Procedure – Manual mode in Section 4, Part B for more information.

b. Timed Mode

- The timer provides timed control of steaming, starts and stops cooking operations.
- To use the timer, simply set the timer to the desired time. The steamer will begin steaming operations as soon as the timer is set. When the timer reaches zero the steaming functions will automatically end and a buzzer will sound for 3 seconds to alert the operator that the cooking cycle is complete.

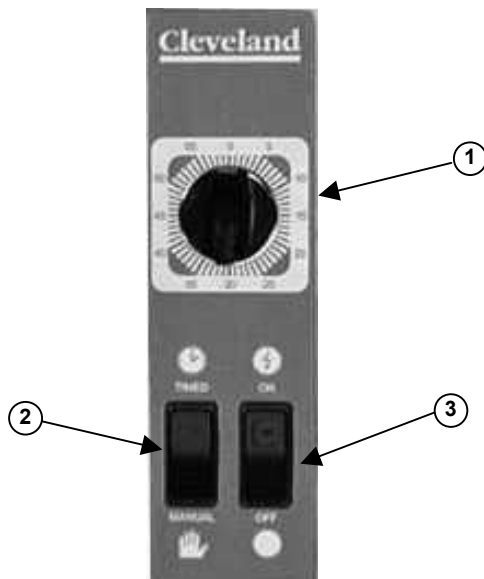

SteamCraft Ultra 3
& 5 Panel (Pictured)

1. DIAL TIMER

This dial timer sets the operating time from 0 to 60 minutes. Turn the dial clockwise until it points to the required number of minutes. When it reaches 0, a buzzer sounds for 3 seconds.

2. TIMED/MANUAL Switch.

The TIMED/MANUAL switch selects the manual or timed operating mode. Pressing the MANUAL (bottom) end of the switch selects the manual mode. Pressing the TIMED (top) end of the switch selects the timed mode.

3. POWER ON Switch and Indicator Light.

(SteamCraft Ultra 3 & 5) When the Red indicator light is ON, power is ON to the unit and the control panel.

4. POWER ON Switch and Indicator Light

(SteamCraft Ultra 10) "POWER ON" Control is located below the top compartment control panel. When the Red indicator light is ON, power is ON to the unit and both control panels.

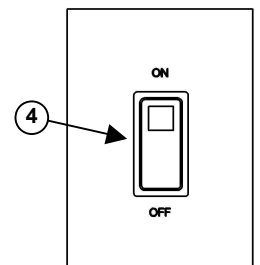

SteamCraft Ultra 10
Power ON Control

Figure 2-1 Dial Timer Control Panel

B. KEYPAD TIMER CONTROL PANEL

(1) Cooking Operations – Keypad Control Panel

For safe, efficient operation of the steamer, the operator must, at a minimum, comply with all cautions, warnings and instructions in the detailed operating procedures and be familiar with the control panel shown in Figure 2-2. The operator must be familiar with all the operating features explained in this manual before attempting to operate the steamer.

(2) Manual and Timed Modes

The steamer has two operating modes: manual and timed. The TIMED/MANUAL rocker switch selects the operating mode. Pressing the MANUAL end of the switch selects the manual-operating mode. Pressing the TIMED end of the switch selects the timed (automatic) operating mode.

a. Manual Mode

The manual mode provides continuous steaming. The operator starts and stops steaming operations manually. See the Operating and Cooking Procedure – Manual Mode in Section 4, Part B for more information.

b. Timed Mode and Use of the Timer

1. Timer Use and Temperature Compensation

- The keypad timer control starts and stops steaming operation, and monitors cooking time and compartment temperature for accurate, efficient, uniform steam cooking.
- The keypad control uses a temperature compensation circuit that effects only the timer. When operating, the timer ONLY COUNTS DOWN WHILE THE COOKING COMPARTMENT IS AT COOKING TEMPERATURE. This provides totally automatic control of the steaming operation and assures uniform cooking as the timer automatically compensates for food product defrosting and/or compartments heat up time. Whenever the steamer is not at cooking temperature 193°F, the timer pauses and the display shows “PAUS”, once temperature is reached a digital display of the remaining time is displayed. When the timer counts down to zero a buzzer will sound, to indicate that cooking is complete and the steam generator will shut down.
- The timer will operate similarly when the steamer is being operated in the manual mode including counting down only when the steamer is at cooking temperature, except that the timer does not start or stop the steaming cycle.

2. Timer Operation

a) Setting the Timer

To set the cooking time, the timer must first be zeroed. The timer can be set only when the cooking time display is clear (00:00). The cooking time display contains four digits. The left two digits are minutes, and the right two digits are seconds. The display 12:34 is set for 12 minutes and 34 seconds. To set the cooking time:

- 1) Change the required cooking time to minutes and seconds.
- 2) Press the number keys for minutes, and then, for the seconds.
- 3) If the cooking time is 99 seconds or less, only press the number keys for seconds.

b) Starting/Stopping the Timer

Press the START/STOP key to start or stop the timer. When the START/STOP key is pressed, the steam generator begins heating the water to steam. Shortly, steam fills the cooking compartment.

- 1) The timer display reads “PAUS” until the cooking compartment reaches proper cooking temperature, or when the timer cycle is paused by pressing the START/STOP key again after the timer has started.
- 2) When the cooking compartment reaches proper cooking temperature, the timer display shows the count down.

NOTE: A timer setting of 10 minutes may in fact take 11 or 12 minutes (or even longer, if the unit was not preheated prior to the start of the cooking cycle) for the timer to count down and the alarm to sound. This is normal. Heating the compartment and food to cooking temperature uses the additional time.

- c) **Shutting Off Alarm/When Timer is Done**
 When the timer counts down to zero, the alarm sounds continuously, the generator stops steaming, and steam flow to the cooking compartment gradually stops.

Press the START/STOP key to silence the alarm. The cooking time display returns to the last time set. Either run this same setting again or clear and reset the timer.

⚠ CAUTION

Press switches with fingertips only. Do not use kitchen utensils or anything sharp to operate the switches.

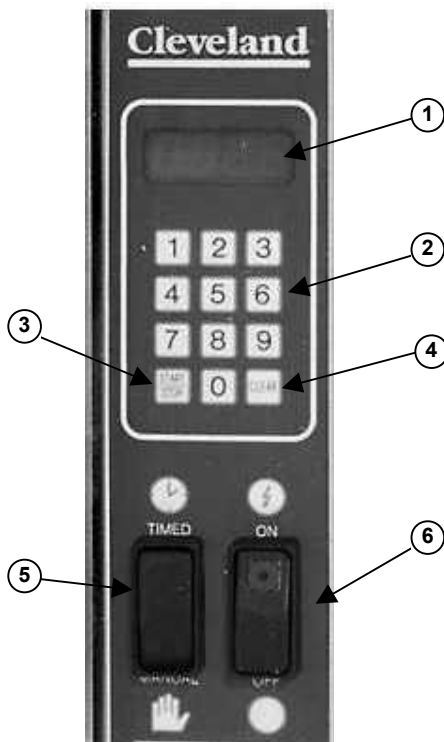

SteamCraft Ultra 3 & 5 Panel (Pictured)

1. TIMER Display.

This four-digit display indicates the minutes and seconds remaining in the count down. The display reads from zero (00:00) to 99minutes and 99 seconds (99:99). It reads pause (PAUS) when the Countdown is halted either by the START/STOP key or by the Temperature compensating circuit.

2. Number Pad Keys.

These keys set the number of minutes and seconds in the timer count down. Pressing the number keys 1 2 3 4 in this sequence, sets the timer for 12 minutes and 34 seconds (12:34).

3. START/STOP Key.

This key starts and stops the timer. In TIMED mode the steaming functions are linked to the timer. In MANUAL mode, the steaming functions are independent of the timer.

4. CLEAR Key.

This key resets the timer to zero (00:00), after it has been stopped. The timer must be zeroed by pressing this key before a new time can be set.

5. TIMED/MANUAL Switch.

The TIMED/MANUAL switch selects the manual or timed Operating mode. Pressing the MANUAL (bottom) end of the switch selects the manual mode. Pressing the TIMED (top) end of the switch selects the timed mode.

6. POWER ON Switch and Indicator Light

(SteamCraft Ultra 3 & 5) When the Red indicator light is on, power is on to the unit and the control panel.

7. POWER ON Switch and Indicator Light

(SteamCraft Ultra 10) "POWER ON" Control is located below the top compartment control panel. When the Red indicator light is ON, power is ON to the unit and both control panels.

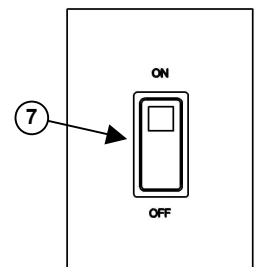

SteamCraft Ultra 10 Power ON Control

Figure 2-2 Electronic Key Pad Control Panel

SECTION 3: GENERAL OPERATION

A. EXTERNAL MAIN POWER SWITCH (Junction Box)

Usually the kitchen's external main power switch is left ON. If the external main power switch was left in the OFF position, turn it ON as follows.

- (1) Check that the water supply valves to the steamer are open.
- (2) Turn the steamers ON/OFF Switch to the OFF position. The TIMED/MANUAL switch and timer settings are not important in this procedure. The control panel circuits are not powered while the ON/OFF switch is set to OFF.
- (3) Refer to the external main power switch in Figure 3-1, and turn ON electric power to the steamer. The steam generator(s) will immediately start blowdown cycles. The blowdown cycle lasts 3 minutes

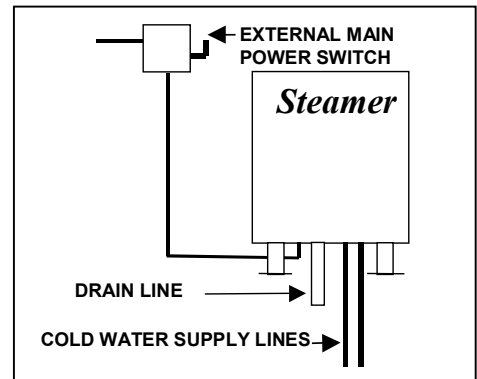

Figure 3-1 External Main Power Switch

B. DOOR INTERLOCK SWITCH (Optional)

The steamer compartments of a SteamCraft Steamer may be equipped with optional automatic steam cutoff switches, which turn OFF the production of steam to a cooking compartment whenever the door to that compartment is opened. **NOTE:** Even though the production of steam ends as soon as a door is opened, it may take up to a minute for residual steam in the system to clear from the steam lines and the cooking compartment. To avoid possible injury always wait until this residual steam has cleared before reaching into the cooking compartment.

⚠ WARNING

SEVERE BURNS may result from exposure to steam.

Do not open the steamer door before steam flow stops. Stand back when opening the compartment door. Open the door slightly to allow steam to vent before looking or reaching into cooking compartment. Do not reach into cooking compartment until the steam has cleared.

Do not reach into steamer or handle hot items without wearing heatproof gloves. Wet or damp gloves conduct heat, and may cause burns when touching hot items.

C. POWER ON (AUTOMATIC FILL)

When each steamer compartment is turned on, it automatically fills the steam generator with water. Use this procedure at the beginning of a shift to prepare the steamer for operation without starting steam generation. When ready to start steam cooking, begin either the Timed or Manual Operating Procedure.

NOTE: The steamer automatically goes into a standby heat mode, as soon as power is turned on to the steamer. This is either accomplished by a thermostat or a timer, which will cycle the heating elements ON and OFF to maintain a standby water temperature of approximately 193°F, once the unit has come up to temperature. This insures that the steamer begins producing steam almost immediately when an actual cooking operation is selected.

- (1) Press the TIMED (top) end of the TIMED/MANUAL switch on the control panel.
- (2) Turn the POWER SWITCH (see Figure 3-2) to the ON Position on the steamer. The red indicator light on the control panel lights, and water fills the steam generator.
- (3) When the generator is full, the steamer automatically stops water flow.
- (4) Once the water has reached the safe level, the elements are cycled ON and OFF and automatically start to heat the water to the standby heat temperature.

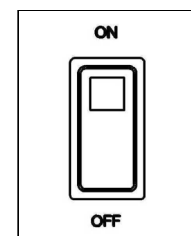

Figure 3-2 POWER Switch

D. INSPECTING THE COOKING COMPARTMENT

At the back of the cooking compartment, a drain screen covers the drain. Refer to Figure 3-3. The screen prevents large food particles from entering and blocking the drain line. Any blockage of the drain line or screen can reduce drainage from the cooking compartment resulting in reduced cooking performance, equipment damage, and a hazard to the operator. A blocked or slow drain may cause:

- Hot water to collect in the compartment and spill out when the compartment door opens.
- Pressure fluctuations in the compartment, resulting in steam leaks around the door gasket, or compartment implosion.
- Reduced convection in the compartment, reducing cooking performance.

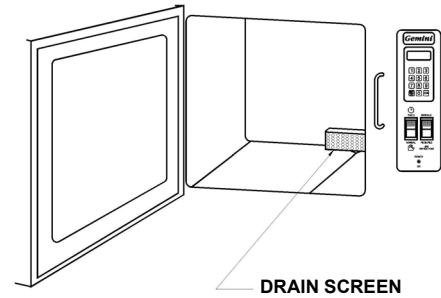

Figure 3-3 Compartment Drain Screen

CAUTION

Steam leaks around the door, cooking compartment flooding, reduced cooking performance, and compartment implosion can be caused by a blocked drain or drain screen. Inspect and clean the drain and drain screen before each use.

Before every steaming operation, inspect the cooking compartment and remove any food scraps or debris from the racks, walls, and floor of the compartment. Pay particular attention to the drain screen.

- (1) DO NOT USE the steamer if water stands in the drain opening. Arrangements must be made immediately to clean the drain in accordance with the instructions found in the Preventative Maintenance and Troubleshooting section of this manual.
- (2) Remove any food or debris that is blocking the drain or screen.
- (3) Be sure the screen covers the drain. The screen prevents large pieces of food from entering and blocking the drain.

E. PREHEATING THE STEAMER

Preheating the steamers can help insure that the best productivity and consistent cooking is obtained. To preheat each steamer, run a cooking cycle of approximately 15 minutes with no food in the cooking compartments.

NOTE: If using a steamer with a keypad timer, set only a 1 minute cooking time for the purpose of preheating, since the timer will only begin to countdown once the steamer has reached a cooking temperature.

- **BEFORE PREHEATING**, inspect and clean the compartment. After preheating, the compartment will be too hot to inspect and clean safely.

F. DESCALING REQUIRED LIGHT FEATURE

When the programmed number of hours have elapsed, the “DESCALE REQUIRED” light will turn on, indicating that descaling of the steam generator must be done (See Figure 3-4). More information on this feature and the descaling procedure can be found in the Maintenance section of this manual, Section 6, Part A (4), Monthly Maintenance.

Note: Switch does not descale unit, it is just a reminder that steamer must be descaled every 4-6 weeks.

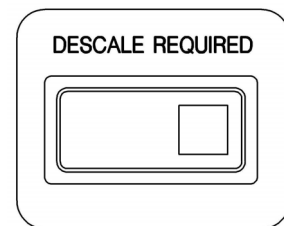

Figure 3-4 Descaling Required Light

SECTION 4: COOKING WITH THE STEAMER

WARNING

When checking inside the steamer always open the door slowly and stand to the side and back away from the steamer. Water leaking from the door gasket can be a sign of a blocked drain. If the drain is blocked, hot water can accumulate inside the compartment and spill out when the door is opened.

A. OPERATING AND COOKING PROCEDURE – TIMED MODE

In timed mode, the timer starts and stops the steaming operation.

- (1) Refer to INSPECT THE COOKING COMPARTMENT IN Section 3, Part D. Inspect and clean the drain and cooking compartment as required.
- (2) If necessary, refer to Preheating the Steamer, in Section 3, Part E, and preheat the cooking compartment.
- (3) Slide the pans of food into the slide racks inside the steamer. Do not place pans or anything else on the bottom of the compartment.

CAUTION

Some foods drip juices. Use a solid catch pan under perforated pans when steaming food that will drip juices. Failure to use a catch pan can cause a clogged drain.

- For best cooking results, use shallow, 2-1/2 inch deep, perforated pans without covers. These give the best heat transfer and shortest cooking time.
- (4) Close the steamer door.
 - (5) Check the control panel settings. At this point the settings should be:
 - The ON/OFF switch is in the ON (top) position.
 - The TIMED/MANUAL switch is in the TIMED (top) position.
 - (6) Set the required cooking time. For KEYPAD MODELS press the START/STOP key. Shortly, steam fills the cooking compartment.
 - (7) When the timer reaches zero, a buzzer will sound; the steam generator stops steaming, and steam flow to the cooking compartment gradually stops. The cooking cycle is complete.
 - For DIAL CONTROL timers the buzzer will stop after 3 seconds.
 - For KEYPAD timers, press the START/STOP key to silence the alarm.

WARNING

SEVERE BURNS may result from exposure to steam. Do not open the steamer door before steam flow stops. Stand back when opening the compartment door. Open the door slightly to allow steam to vent before looking or reaching into cooking compartment. Do not reach into cooking compartment until the steam has cleared. Do not reach into steamer or handle hot items without wearing heatproof gloves. Wet or damp gloves conduct heat, and may cause burns when touching hot items.

- (8) Carefully open the cooking compartment door, and remove the pans from the slide racks.
- If the steamer will be used again in a few minutes shut the door to maintain the cooking compartment temperature.
 - If another use is not planned for more than half an hour, leave the cooking compartment door slightly open to reduce internal pressure while the steam condenses and the compartment cools.
 - If the steamer is not being used again during this shift, perform the Power OFF and Shut Down and Cleaning Procedures.

B. OPERATING AND COOKING PROCEDURE – MANUAL MODE

Manual mode allows the operator to personally control the cooking functions. The operator starts and stops the steaming operations, and sets the cooking time including time for steam generator, compartment and food heat-up time. Use the manual-cooking mode for:

- A continuous supply of steam.
- Cooking times longer than the timer can measure.
- Maintaining the compartment temperature between cooking batches.

(1) Using the Timer in Manual Mode

The timer may be used when the steamer is operating in the manual mode, but it will not start or stop the steaming cycle.

(2) Manual Cooking Procedure

Follow this procedure when cooking with the steamer in manual mode.

1. Refer to INSPECT THE COOKING COMPARTMENT in Section 3, Part D. Inspect and clean the drain and cooking compartment as required.
2. In manual mode, the operator can bring the compartment to cooking temperature by either preheating or increasing the cooking time. If the operator chooses to preheat the cooking compartment manually, refer to Section 3, Part E, PREHEATING THE STEAMER.
3. Slide the pans of food into the slide racks inside the steamer. Do not place pans or anything else on the bottom of the compartment.

 CAUTION
Some foods drip juices. Use a solid catch pan under perforated pans when steaming food that will drip juices. Failure to use a catch pan can cause a clogged drain.

- For best cooking results, use shallow, 2-1/2 inch deep, perforated pans without covers. These give the best heat transfer and shortest cooking time.
4. Close the steamer door. Select the manual mode by pressing the MANUAL (bottom) end of the TIMED/MANUAL rocker switch. The steaming cycle starts as soon as the switch is pressed. Shortly, steam fills the cooking compartment.
 5. If the timer is used to monitor cooking.
 - a) Set and if necessary start the timer. (Remember that if a KEYPAD timer is used in this way it will only count down time when the steamer is at cooking temperature.)
 - b) When the timer reaches zero, the buzzer will sound, and cooking is done. Remember, in manual mode, the timer does not stop the steaming functions.

6. To stop manual mode steaming, press the TIMED (top) end of the TIMED/MANUAL rocker switch. The generator stops steaming, and steam flow to the cooking compartment gradually stops.

 WARNING
SEVERE BURNS may result from exposure to steam. Do not open the steamer door before steam flow stops. Stand back when opening the compartment door. Open the door slightly to allow steam to vent before looking or reaching into cooking compartment. Do not reach into cooking compartment until the steam has cleared. Do not reach into steamer or handle hot items without wearing heatproof gloves. Wet or damp gloves conduct heat, and may cause burns when touching hot items.

7. Carefully open the cooking compartment door, and remove the pans from the slide racks.
 - If the steamer will be used again in a few minutes shut the door to maintain the cooking compartment temperature.
 - If another use is not planned for more than half an hour, leave the cooking compartment door slightly open to reduce internal pressure while the steam is condensing and cooling.
 - If the steamer is not being used again during this shift, perform the Power OFF and Shut Down and Cleaning Procedures.

SECTION 5: SHUTDOWN AND CLEANING PROCEDURES

A. STEAM GENERATOR BLOWDOWN

(1) Power Off (Automatic Blowdown)

Blowdown occurs automatically when the steamer is turned off at its ON/OFF switch. During blowdown, the steam generator drain solenoid is rinsed with fresh water, and the boiler is drained. Blowdown at frequent intervals helps decrease mineral buildup in the steam generators, and reduces the frequency of descaling and other maintenance.

(2) Blowdown Frequency

The supply water quality determines how often blowdown must be performed. The higher the feed water, total dissolved solids, and particulate, the more frequently blowdown must be performed. A determination should be made at the time of installation whether additional blowdown frequency will be required as part of the daily maintenance based on the water quality analysis done as part of the installation. This information should be noted in the daily maintenance program developed for the equipment. If the local water supply meets the minimum supply water quality standards, observe the following guidelines to establish proper blowdown scheduling.

- For units without a water treatment system, blowdown must be performed after every 4 hours of operation and at the end of each shift.
- For units with a water treatment system, blowdown must be performed at the end of each shift.

(3) Blowdown Procedure

When the steamer is turned off, its blowdown cycle starts and runs automatically. The complete cycle takes approximately 3 minutes.

1. Turn the ON/OFF Switch to the OFF position to turn off the steamer. The red indicator light in the ON/OFF switch turns off. Do not turn power off at the main power switch during blowdown.
2. Automatically, the drain valve opens and begins to empty water from the steam generator.
3. The fill valve(s) opens for 3 minutes, to help cool the drain water and clean the drain valve.
4. At the end of the 3-minute blowdown cycle, the fill valve closes.
5. When blowdown is complete, the steamer can be restarted, or the shut down procedure completed.
 - To restart the unit, refer to POWER ON (AUTOMATIC FILL) in Section 3,Part C.
 - To shut down the unit, refer to SHUT DOWN AND CLEANING, below.

B. SHUT DOWN AND CLEANING

This procedure should be performed at the end of each day or shift.



- (1) Refer to Power OFF (Automatic Blowdown), and turn off the steamer compartment. Allow 3 minutes for the complete blowdown cycle.

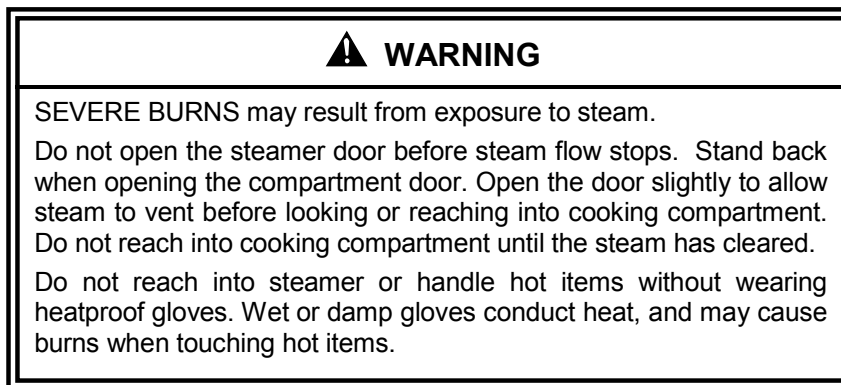

- (2) Open the steamer doors and allow steamer to cool.

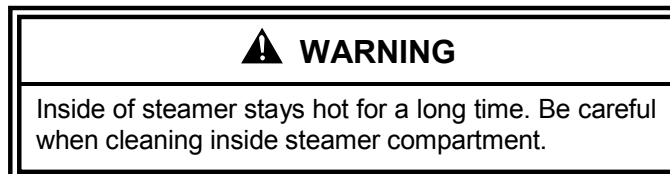

- (3) Remove the slide racks. Wash and rinse racks separately or clean them in a dishwasher according to health requirements. Do not remove the drain screen.

- (4) Remove any spilled food from inside compartment and clear any residue from the drain screen. Clean the interior of the compartment thoroughly. Use a soft bristle brush to remove stubborn food particles. Do not use abrasive cleaning compounds or steel wool. Rinse inside of steamer compartment with clean water.



- (5) Clean the door assembly.

- Remove the inner door assembly (see Figure 5-1).
- Note the keyhole slots in the outer door and the retaining pins on the inner door assembly. Grasp the inner door assembly at the sides and lift up and then towards you to remove the assembly.
- Clean all surfaces of the inner door assembly, as well as the inside of the outer door, by wiping with a damp cloth.
- Rotate the inner door assembly 180° and replace it by sliding the retaining pins into the keyhole slots. Either long edge of the gasket assembly can be positioned at the top. Periodic rotating of the door assembly will increase the door gasket life.

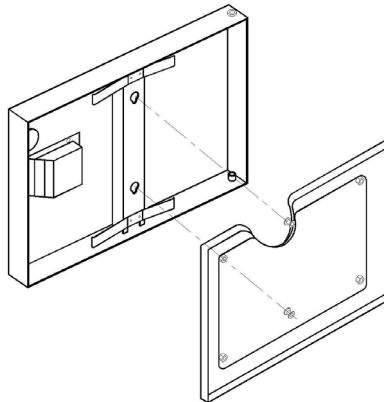

Figure 5-1 Inner Door Assembly

- (6) Replace the cleaned slide racks.
- (7) Wipe the exterior with a damp cloth only. **NEVER HOSE DOWN THE STEAMER.** Electrical components inside the unit will not function correctly if wet or damp.
- (8) After cleaning, leave the steamer door open until the next steamer operation. This prevents compartment odor buildup and increases gasket life

SECTION 6: PREVENTATIVE MAINTENANCE AND TROUBLESHOOTING

A. MAINTENANCE

Maintenance on the steamer must be performed on a regular basis to keep the unit running properly. By following the maintenance instructions in this Section and in the separate Installation Manual, problems with the steamer will be kept to a minimum. As with any preventative maintenance schedule, the frequency of steamer maintenance may need to be increased, depending on equipment usage and water quality. If problems do occur, refer to the Troubleshooting Guide in this Section. For more information on product and services, contact your sales representative.

(1) Maintenance Records

Make a file solely for maintenance records. Keep a written record of daily, weekly, monthly, and yearly maintenance. These records will protect warranty coverage, help personnel to know when to perform various maintenance procedures, and assist service personnel.

(2) Daily Maintenance

a. Blowdown Steam Generator

Blowdown each steam generator at least every four hours according to the steam generator blowdown instructions in Section 5.

b. Clean the Steamer

Clean interior and exterior of the steamer according to the shutdown instructions in Section 5.

(3) Weekly Maintenance

Clean Drain

CAUTION

Steam leaks, pressure buildup in the cooking compartment and poor steaming performance can be caused by a blocked drain line or screen. Blocked or slow drains are dangerous because hot water can collect in the compartment and spill out when opening the compartment door.

This steamer is equipped with a drain screen in the back of each cooking compartment. Never operate the steamer without the screens in place. The screen prevents large food particles from entering and blocking the drain line. Any blockage of the drain line can cause a pressure buildup in the compartment, resulting in steam leaks around the door gasket. Drain line blockage also adversely affects convection action of the steam in the compartment, which is necessary for optimum performance.

- a. Inspect the drain screen and drain line for blockage. Rotate the drain screen 90 degrees to inspect the drain opening. Clean the opening and restore the screen to its operating position.
- b. Clean drain with an USDA approved drain cleaner, once a week. Follow the instructions of the manufacturer of the cleaner.
- c. Flush drain with clean water.

(4) Weekly/Monthly Maintenance

Descal Steam Generator

Steam generators should be descaled at least once a month, depending on scale buildup. Alternately, they can be descaled weekly with smaller amounts of solution, if this frequency better suits your maintenance schedule. If you have serious steam generator scale buildup, a water treatment system should be installed for the steamer or if this is not possible the frequency of descaling should be increased. This unit is equipped with a Descaling reminder light to assist in the scheduling of this maintenance. (Note: the descaling light has been factory set for an operating time of approximately 1 month or 300 hours of operation, if weekly descaling has been chosen it will be necessary to have the descaling timer reset to reflect this schedule by a qualified service technician). When this light comes on arrangements should be made to descale the steam generator as soon as feasible. Cleveland Range, Inc. recommends the use of **DISSOLVE® Descaler Solution, Cleveland Range Part No. 106174**. No other system of steamer descaling should be used.

NOTE: Part No. 106174 is the Part No. for a case (6 1-gallon containers) of **DISSOLVE®** descaler. It is also available in 5-gallon containers as Part No. 1061741.

THESE INSTRUCTIONS ARE FOR USE WITH **DISSOLVE®** DESCALER SOLUTION ONLY.

- **Health Hazard Data, Effects of Overexposure** – This product may cause a burning sensation to eyes or skin.
- **Emergency and First Aid Procedures** - In case of eye contact, immediately flush eyes with plenty of water. If irritation persists seek medical attention. In case of skin contact wash with soap and water. If inhaled, remove to fresh air and if burning persists, call a physician. If swallowed, drink 1 or 2 glasses of water and call a physician.
- **Spill or Leak Procedures** – Rinse with plenty of water to dilute. Sodium carbonate or calcium carbonate may be used to soak up liquid. Considered non-hazardous, spent material may be disposed of in a sewer system with water flush.

WARNING

The liquid solution in Cleveland Range Descaler Solution Part No. 106174 can be harmful if not handled properly. Follow these basic safety rules for handling and using this product.

Wear protective clothing when mixing or applying chemical cleaners.

Wear rubber gloves, and splash goggles.

Avoid breathing fumes. If liquid comes in contact with skin, wash with soap and water.

If chemical contacts eyes, flush with water. If irritation persists seek medical attention

If chemical is swallowed or ingested, drink 1 or 2 glasses of water and call a physician.

CAUTION

Do not use any other product or method of descaling other than the **DISSOLVE®** Descaler method using Part No. 106174.

Weekly/Monthly Maintenance (continued)

ATMOSPHERIC STEAM GENERATOR DESCALING PROCEDURE (For *DISSOLVE*® Descaler Solution Part No. 106174)

1. This procedure will take approximately 1 hour and 30 minutes to complete. This entire procedure should be read and fully understood, before beginning the actual descaling operation.
2. Zero the timers or for manual only models set the selector to OFF.
3. Open both doors to the cooking compartments.
4. Set the TIMED/MANUAL switches to TIMED.
5. Set the ON/OFF switch to the OFF position. (The Unit will undergo a normal blowdown cycle, which Should take approximately 3 minutes to complete).
6. When the unit has completed draining, turn the ON/OFF switch to ON to refill the unit. Do not start the timer. Leave the doors open.



Figure 6-1 Descaler inlets

NOTE: Be ready to pour in the descaling solution when the power is turned ON.

NOTE: DO NOT HEAT THE UNIT DURING DESCALING.

7. While the unit is filling with water, remove the descaling port plug(s) located at the top of the unit (See Figure 6-1), and add 1 gallon of *DISSOLVE*® descaler solution (P/N 106174) to each port.
 - While adding liquid to the unit through the Descaler inlets; pour it in slowly so as to avoid overflow.
8. When the automatic fill has ended, add an additional 1-gallon of water to each port.
9. Replace the cap and let the unit stand for 1 hour.
10. At the end of 1 hour, set the ON/OFF switch to the OFF position to blowdown the steamer. After the 3-minute drain cycle completes turn the unit back ON. After the filling has stopped, add 1½ gallons of water to each port, and then turn the unit OFF. This will drain any residue from the water level control assembly.
11. After the steamer has completed draining, close the steamer door(s), set the ON/OFF Switch to the ON position. The unit will fill with water.
12. Set the timers for 20 minutes, and turn them on (KEYPAD MODELS). The unit will come up to normal operating temperature.
13. At the end of 20 minutes of cooking, turn off the alarm (if necessary) and set the ON/OFF Switch to the OFF position. The unit will go through a 3-minute drain cycle.
14. This is the final blowdown. The steamer is now ready for normal operation.
15. When done cleaning, reset the descale indicator light timer to zero by pressing the “DESCALE REQUIRED” light rocker switches, and resume normal operation.

Optional Weekly Cleaning Intervals

Follow same process as above, except add one quart of *DISSOLVE*® (Part No. 106174) instead of one gallon to each generator.

B. OPERATORS TROUBLESHOOTING GUIDE

The Troubleshooting guide includes a list of symptoms that may be encountered during routine operation and maintenance. The first column on the left (PROBLEM) describes these symptoms. The second column lists the possible causes for the problem in column one. The third column lists possible remedies for the problems and causes in columns one and two. The causes and remedies are listed in the order they should be checked, with the least costly and easiest to repair listed first. The third column also refers to notes that are grouped at the end of the troubleshooting guide. Refer to these notes when instructed to do so.

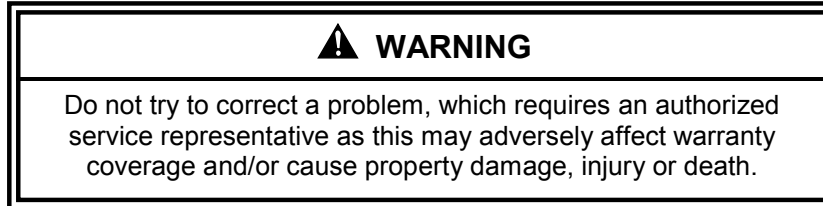

Table 6-1 Trouble Shooting Guide

PROBLEM	POSSIBLE CAUSE	REMEDY/REFERENCE
Switch light does not turn ON when ON/OFF switch is pressed ON.	Power turned off at external main power switch or breaker.	Turn ON power at external main power switch or circuit breaker.
	Circuit breaker on back of unit has tripped. (21CET8 and 21CET16 only)	Reset circuit breaker. If condition repeats itself see note #1.
	Internal fuse has blown. (21CET16 only)	See note #1.
	Internal main transformer has failed.	See note #1.
	Inoperative controls or failed switch.	See note #1.
Power ON and steam generator does not fill.	Water supply to steamer shut off.	Open water supply valves.
	Water line strainer and/or external filter system is clogged	Clean water supply strainer and/or filter system.
	Solid particles have partially blocked the drain valve or valve is stuck open.	Blowdown unit to rinse drain. The unit needs to be descaled with a Cleveland Range approved descaler as soon as possible. If condition persists, see note #1.
	Inoperative Solenoids or controls.	See note # 1.
ON/OFF switch light ON and steamer does not make any steam in manual or timed mode.	Water supply to steamer shut off.	Open water supply valves.
	Water line strainer and/or external filter system is clogged	Clean water supply strainer and/or filter system.
	Door interlock switch not engaged or has failed. (On units equipped with a door interlock only)	Close steamer doors completely. If problem persists see note #1.
	Heating elements covered in scale.	Descalate steam generator with Cleveland Range approved descaler.
	Hi limit has tripped	See following section "high limit has tripped"
	Heating elements have failed.	See note #1.
	Inoperative controls or solenoid.	See note #1.
Hi limit has tripped	Unit has temporarily overheated.	Turn unit OFF for 3-minutes to blow down unit and then turn back ON, to drain and refill the generator.
	Scale build-up in generator.	Descalate generator with Cleveland Range approved descaler.
	Bad high limit.	See note #1.
	Inoperative controls.	See note #1.

(Continued on next page)

Table 6-1 Trouble Shooting Guide (Continued)

PROBLEM	POSSIBLE CAUSE	REMEDY/REFERENCE
ON/OFF switch light ON but timer does not light. (Electronic Timer Models only).	Timer transformer has failed.	See note #1.
	Inoperative controls.	See note #1.
Steam flow does not stop when timer stops.	Operating in manual mode.	Switch to timed mode for timer to be effective.
	Heat Standby Switch has loosened or failed closed. (21CET16 only)	See note #1.
	Heat standby timer is stuck closed. (21CET8 or 24CEA10 only)	See note #1.
	Inoperative controls inside cabinet.	Turn off electricity at main external power switch. See note #1.
Steam and/or water draining around compartment door. See WARNING under note #7.	It is common for a small amount of water to condense around the door.	This is normal operation of the unit. No action is necessary.
	Water supply to condenser turned OFF.	Open water supply valve.
	Hot water instead of cold water connected to condenser fitting.	Make proper connections. Refer to section on water supply in installation manual. See note #3.
	Compartment drain clogged or covered.	Clean drain with USDA approved drain cleaner. If condition persists see note #1
	External drain not properly installed, should be free-air vented and pitched down.	See note #2 and #3.
	Door gasket or door parts worn.	See note #1.
	Steamer not level.	See note #2.
	Condenser inoperative	See note #1.
Abnormal amount of steam coming from drain.	Hot water instead of cold water connected to condenser fitting.	Make proper connections. Refer to section on water supply in installation manual. See note #3.
	Water supply to condenser turned OFF.	Open water supply valve.
	Condenser water line strainer and/or nozzle are clogged.	Clean out condenser water supply strainer and or condenser nozzle (see note 1).
	Water supply line to the condenser blocked, broken, or leaking.	Repair or replace water supply line. See note #1.
	Inoperative condenser solenoid.	See note #1.
	Solid particles have partially blocked the drain valve open.	Blowdown unit to rinse drain. If condition persists see note #1.
	Inoperative controls	See note #1.
Water leaking from the bottom of cabinet.	Broken or loose plumbing inside steamer cabinet.	Turn off electricity at main power switch and close water supply valve(s). See note #1.
Water leaking from water pipes or drain lines.	Plumbing needs repair.	See note #3.
Compartment bottom dirty with food drippings.	Juices and/or food leaking from pans	Put a solid pan under perforated pans to catch drippings, or put less food in pan.

(Continued on next page)

Table 6-1 Trouble Shooting Guide (Continued)

PROBLEM	POSSIBLE CAUSE	REMEDY/REFERENCE
Food takes too long to cook. To verify the steamers proper operation, see note #6.	Not enough steam movement in compartment. Hot water connected to condenser line.	Make proper connections. See note #3.
	Condenser water turned OFF.	Turn ON water to condenser.
	Pans too close to the bottom of the cabinet.	Put pans in racks near top of cabinet.
	Steam generator scale buildup.	Descale steam generator with Cleveland Range approved descaler.
	Compartment over loaded with too much food.	Put less food into pan. Use fewer pans
	Food is frozen.	Increase cooking times for frozen food.
	Voltage too low for unit.	See note #4.
	Food is being cooked in covered solid pans.	Remove covering. Steam must have direct access to the food for cooking to take place, use perforated pans.
	Suggested cooking times are usually listed for cooking at sea level.	Extend cooking times for altitudes above 2500 feet.
Reduced steam flow into cooking compartment	Inoperative controls or heating element. (21CET16 and 24CEA10 only)	See note #1.
	Steam generator scale builds up.	Descale steam generator with Cleveland Range approved descaler. See note #6.
	Voltage too low for unit.	See note #4.
Water coming from drain even when not cooking.	Solid particles have partially blocked the drain valve open.	Blowdown unit to rinse drain. The unit has to be descaled with a Cleveland Range approved descaler as soon as possible. If condition persists, see note #1.
	Condenser valve is bad.	See note #1.
	Drain valve is bad	See note #1.
Descale Required Indicator is lit. Note: Switch does not descale unit, it is just a reminder that steamer must be descaled every 4-6 weeks.	If unit is new, or has just been descaled	Press switches to reset descale timer.
	Unit needs descaling	Descale unit with Cleveland Range approved descaler. After descaling is completed, press switch to reset descale timer.
	Bad or improperly set descale timer.	See note #1.
Water is flowing out of the steam ports into the cooking compartment	Water level probes are dirty and are not sensing properly.	Turn OFF the water supply to the steamer and descale the unit manually with Cleveland Range approved descaler by filling the unit with descaler and water through the descaling port. If the condition persists see note #1.
	Inoperative controls or solenoid.	See note #1.
ON/OFF switch light on and steamer does not make steam in timed mode.	Timer fuse has blown (Electronic timer models only).	See note #1.
	Inoperative timer control or damaged wiring.	See note #1.

(Continued on next page)

Table 6-1 Trouble Shooting Guide (Continued)

PROBLEM	POSSIBLE CAUSE	REMEDY/REFERENCE
Water comes out of the descale port.	Descal cap is missing.	Install the descale cap. The descale port must be closed tightly for the steamer to operate properly. If missing see note #8.
	Descal cap is loose.	Tighten the descale cap. The descale port must be closed tightly for the steamer to operate properly.
	Descal cap and/or gasket is damaged.	See note #8.

TROUBLESHOOTING NOTES

1. If problem is inside the steamer, call an authorized service representative. Cleveland Range, Inc. will not pay for warranty repairs by unauthorized repair centers.
2. Proper installation of the SteamCraft steamer is the responsibility of the owner or installer. Refer to Cleveland Range, Inc. warranty.
3. Repairs to external plumbing should be done by a Licensed Plumber.
4. A Licensed Electrician should do repairs to external wiring.
5. For more information on products and services, contact your nearest Authorized Sales Representative. Call factory for a preventative maintenance program, descaling kits, descaling information, and water treatment systems: USA: (800) 338-2204, Canada: (800) 427-6668.
6. To evaluate whether a convection steamer is producing normal cooking performance, conduct the Egg Test as follows (Note: This test is not valid for SteamCubs or pressure steamers). A properly operating steamer will produce cooked eggs as follows.

Turn on the steamer so that steam is being produced. After steam has begun to enter the compartment, preheat the compartment by turning the timer on for ten minutes.

After the compartment is preheated:

- Place two fresh eggs in a perforated pan.
- Place pan in the center rack of the cooking compartment.
- Set timer for 10 minutes and turn on.
- After five minutes, open door and remove one of the eggs.
- Close the door right away and allow second egg to cook.
- Crack open first egg and it should be soft boiled.
- After timer goes off, open door, remove egg and crack open. It should be hard-boiled.

7. Whenever opening the door to the steamer, follow the safety guidelines contained in the following Warning:

 WARNING
<p>When checking inside the steamer always open the door slowly and stand to the side and back away from the steamer. Water leaking from the door gasket can be a sign of a blocked drain. If the drain is blocked, hot water can accumulate inside the compartment and spill out when the door is opened.</p>

8. Replacement descale caps and gaskets can be ordered from a Cleveland Range authorized maintenance and repair center.

SECTION 7: STEAM COOKING GUIDELINES

A. Introduction:

Steam Cooking is an excellent way to prepare countless foods. With large and small quantities you will find cooking to be efficient, economical, fast and convenient. Food can never burn-pans will never boil over-there is no heavy lifting of water in pots-no scouring of containers-no waiting for boiling to start. Steam cooking is efficient, economical and convenient. From the Steamer to the steam table, it saves money in labor/time, and, of course, the quality and consistency remains the same.

Seafood:

Steaming seafood is an excellent method of cooking a variety of seafood. From the freezer directly into the steamer gives you, the operator, portion control on expensive seafood products. Steamed fish is tender, succulent, and flaky and table ready in a matter of minutes.

Vegetables:

Steam cooking vegetables, either fresh or frozen, enhances color, improves flavor, and helps retain vitamins when recommended timer settings be followed. Steaming fresh vegetables on perforated pans gives best results.

Meat:

Steam provides an even, intense and penetrating heat, which, because of its nature, cooks meat with minimal shrinkage. The meat is tender, moist and flavorful. Stews, pot roasts, ham and corned beef are excellent steam cooked. Steam tenderizes stewing fowl. It produces excellent meat for sandwiches and salads, both moist and savory and is easily sliced.

Desserts:

Many kinds of cornstarch pudding and custard desserts are prepared by steaming. Fruit desserts such as steamed "Baked Apples" are another suggestion. Core the apple and arrange on a shallow pan. Fill the cored apple with cinnamon and sugar, then steam. If desired, browning under the broiler may finish the apples. Applesauce is another steam application, as are stewed pears or peaches. Dried fruit, properly marinated, turn out beautifully.

Additional Ideas:

There are many applications for steam cooking besides vegetables and seafood:

- Eggs can be soft cooked, coddled, hard cooked, poached, scrambled, and made into custard or pudding. 25 dozen eggs can be hard cooked in 12 minutes using three 12" x 20" x 2½" perforated pans in one compartment of the steamer.
- Momentary steam blanching of fruits, including citrus and pineapple, simplifies skin removal.
- Dumplings, steamed breads, muffins, hot cereal, pasta, noodle and rice can be prepared or reheated in the steamer.
- Beef and other meat, cooked by steaming, is moist, tender and flavorful. The meat drippings from the catch pan can be used to make gravy soups or clear stock, as a salt free broth.
- Turkey, chicken and other poultry are tender, juicy when steamed then combined into a casserole, added to BBQ sauce, or browned under the broiler. Chicken pieces can be breaded, steamed, then finished in the deep fryer. It is crisp, delicious, and juicy.
- Hot Dogs, sausages and other variety meats remain plump and juicy when steamed.
- Entrees such as lasagna, macaroni and cheese, or beef stew can be prepared from scratch. Frozen institutional packs can be reheated in the steamer. It is not necessary to cover.

B. SIZING UP PAN CAPACITY:

(1) Serving Sizes – How Much? How Many?

How to estimate portion size and number of servings from a standard steam table pan.

- A 12" x 20" x 2½" (65mm-1/1GN) solid pan will hold 1-7/8 gallons or 240 fluid ounces (30 liters or 7200ml).

Table 7-1 Serving Size

240 Fluid Ounces Produces (7200ml)		
<u>Portion Size</u>	<u>Number of Servings</u>	<u>Type of Product</u>
10 oz (300ml)	24	Stew, Casserole, Lasagna
8 oz (240ml)	30	Soup, Bisque
6 oz (180ml)	40	Soup, Bisque
4 oz (120ml)	60	Mashed Potatoes
2 oz (60ml)	120	Sauce
1 oz (30ml)	240	

- Number of servings of cooked vegetables from one 12" x 20" x 2½" perforated pan. (65mm-1/1GN)

Frozen Vegetables Yields:

10.0 lbs. (4.5kgs)	Approx. 50-3 oz (90ml) servings
7.5 lbs. (3.4kgs)	Approx. 30-3 oz (90ml) servings
5.0 lbs.	Approx. 25-3 oz (90ml) servings

(2) Reference Charts for Typical Pan Capacities

Pan Capacity stated in terms of usable fluid ounces per straight side pan. When filled to overflowing, estimate a higher figure per pan.

Width x Length (inches)	12 x 20	12 x 13	12 x 10	12 x 6	10 x 6	6 x 6
Steam Table Pan Size	Full Size	2/3 Size	½ Size	1/3 Size	¼ Size	1/6 Size
<u>Pan Depth</u>	<u>Fluid Ounces</u>					
2 ½"	240	175	125	75	55	35
4"	420	294	208	125	95	55
6"	625	435	314	186	140	82

Pan Capacity stated in quarts per straight-sided pan. Capacity as stated is to overflowing.

<u>Pan Depth</u>	<u>Fluid Quarts</u>					
2 ½"	7 7/8	5 ¾	4 1/8	2 5/8	1 7/8	1 1/4
4"	13 ½	9 ½	6 ¾	4 1/8	3 1/8	1 7/8
6"	20	14	10 1/8	6 1/8	4 5/8	2¾

Can Size and Volume

<u>Can Size</u>	<u>Cup</u>	<u>Net Weight or Fluid Oz.</u>
No 2 ½	3 ½	27-29 oz
No 3	5 ¾	51 fluid oz.
No 10	12-13	6 ½ - 7 lb., 5 oz.

C. CONVECTION STEAMER – SUGGESTED TIMER SETTING GUIDELINES ELECTRONIC CONTROLS WITH THE COMPENSATING THERMOSTAT

Timer settings are approximate due to the differences in food quality, age, shape and the degree of doneness desired. It is not necessary to add water. Perforated pans are recommended. Starred items (*) must be cooked in solid pans. Items marked with two stars (**) require handling in two steps. First steam for approximately ½ the time shown, remove from steamer, separate thawed portion, or stir, and return to steamer for the time remaining. The compensating feature of the timer allows the cooking compartment to reach temperature before the preset time starts to count down. **Note:** Times may need to be increased slightly when using manual timers.

VEGETABLES:	Fresh	Frozen		Fresh	Frozen
Artichoke	12		Spaghetti squash, halves	15-18	
Asparagus, spears	4	6	Tomatoes, whole, sliced*	1	
Beans, green, 2" cut	6	5	Turnips, whole	20-25	
French cut	4	5**	Zucchini, sliced	2-4	2-4
Whole	6	4			
Broccoli, spears	3	2-3	<u>SEAFOODS:</u> Steam all seafood on a perforated pan		
Flowerets	2-3	1-2	with catch pan		
Chopped		6-8	Clams in shell	3-5	
Brussels sprouts	4-5	4	Cod fillets, 5 oz.	3	4
Cabbage,	2		Portions		
Whole to remove			Crab legs, king		4-6
Leaves for cabbage rolls			Snow crab		2-4
Carrots-baby whole	10	6	Crab, live, 4 oz.		
Sliced,	7-8	3	3/4 - 1 lb.	12	
Diced		2	Halibut, 6-8 oz.	4-6	6-8
Cauliflower,			Portions		
Flowerets	4-5	3-4	Lobster, whole, 1 lb.	7-9	
Whole	10		Lobster tails, 8 oz.		8-10
Celery, Dai. Cut 1½"	3		Defrosted, butterflied		4-6
Diced	2	1	Mussels in shell	2	
Minced	1		Oysters in shell	2-4	
Corn, yellow, whole		2	Red snapper, 8 oz.	4-5	4-5
On cob,	6	12**	Salmon steak, 8 oz.	6	7
Cobbettes	6	12**	Shrimp, 10 ct. per lb. IQF	3	4-6
Eggplant, sliced,	1		5lb. Block, peeled &		
Mixed Vegetables		3-4	Deveined 30 ct.		6-8
Mushrooms,			5lb. Block, green, (nested pan)		6-8
Whole 1½"	3		26-30 ct.		10**
Sliced	1				
Onions, diced, sliced	2-3	1	<u>EGGS (Medium Sized):</u>		
Whole	4	2	Hard cooked for egg		
Peas, green		2	Salad, potato salad	10-12	
Potatoes, whole 8 oz.	30-35		Soft cooked	3	
Peeled, quartered,	12-19		Coddled	6	
Fresh peeled, diced	8-10		Poached in a cup	2-3	
Potatoes, sweet,	30-35		Scrambled*	6-7**	
Whole					
Spinach leaf	2	21**	<u>FRUITS:</u>		
Chopped		21**	Blanch for peeling		
Squash, acorn halves			Fresh: Avocado	1	
Butternut, quartered					
Squash whipped*		20**			

(Continued)

(continued from previous page)

FRUIT:	Fresh
Apple, cored	1
Grapefruit	1
Orange	1
Apricot	1
Pineapple, whole	2
Dried: add water to re-hydrate	
Apple	10
Apricot	10
Peach	10
Pear	10
Prune	10

MEATS & POULTRY:

Cook meats and poultry in nested pans, as juices can be used for gravy, sauces, beef stock and soups. The portion size, thickness, grades, should be considered when selecting a timer setting for doneness.

POULTRY:	Fresh	Frozen
Turkey, whole	6-8 min./lb.	6-8 min./lb.
Chicken, 5-8 oz.		
Breaded piece 18-20 min.		
halves, 1 1/4-1 1/2 lb. per half	20-24 min.	

PORK, SAUSAGE,

HOT DOGS:	Fresh	Frozen
Pork, Chop, 4 count/lb.	10 min.	
Italian sausage, 4 oz.	10 min.	
Ribs, 3lb. and down	20-26 min.	
Hot-dogs, 8 count/lb.	2 min.	

BEEF:	Fresh	Frozen
Cubes, 1 1/2"	6-7 min./lb.	6 min./lb.
Ground chuck for chili	4 min./lb.	4-6 min./lb.
Pot-roast, choice	8-12 min./lb.	
Rump roast, choice		
Boned, rolled, tied	12 min./lb.	
Meat loaf, 4lb. Loaf	5 min./lb.	
Liver, baby beef, 8oz.	2-4 min./lb.	2-4 min./lb.
Corned beef, 6-8lb. cut, add 1/2" water		
Pan	20-23 min./lb.	

STEAKS: :

Using a 3/4" to 1" steak, the steaming time listed below produces a "rare" steak. A "well done" steak is first steamed to the "rare" stage, then broiled or grilled for 1 1/2 minutes on each side. This "well done" steak shrinks less, is more tender and juicy; and, when served, is the same size as the "rare" steak.

STEAKS: :	Fresh
Sirloin Patties	
Chopped 8 oz	4 min.
Ribeye, 8 oz.	4 min.
Top butt steak 6 oz.	4 min.
8 oz.	6 min.
Filet Mignon, butterflied –	
4 oz.	3 min.
6 oz.	3-4 min.
8 oz.	4 min.
10 oz.	5 min.
16 oz.	8 min.
(Chateaubriand)	
Strip steak - 10-oz.	5 min.
12 oz.	7 min.
T-bone 12 oz.	5 min.
16 oz.	8 min.
18 oz.	8 min.
22 oz.	10 min.

PREPARED ENTREES:

	Fresh	Frozen
Full Size Pans		
Cabbage rolls, stuffed*	25 min.	20 min.
Cover with tomato Sauce & serve		
Casserole dishes*		
Beef Stew	20-25 min	25-30 min.
Stroganoff	20-25 min.	25-30 min.
Lasagna* fresh	20-25 min	25-30 min.
Reheat ea. serving 4"	6-8 min.	12 min.

DEHYDRATED FOODS:

Potatoes* 2 1/2" random sliced
Plus 5 cups cold water /lb. 12 min.

RICE & BEANS:

Rice, long grain
 4 cups cold water/lb. 17 min.
Beans, pre-soaked overnight,
 1 lb. Beans = 1 1/4 qt. Water 45 min.
Beans* unsoaked,
 1 lb. Beans x 1 1/2 qt. water 2 1/2 Hours
Refried beans, 2-#10 cans 15-17 min.

PASTA:

Steam in nested pans. Place pasta on 2 1/2" perforated pan used as a liner in a solid 2 1/2" pan. Cover pasta with cold water.

Egg noodles, 1 1/2" wide	4-6 min. **
Lasagna noodles	10-12 min. **
Macaroni, shells, elbow	10-12 min. **
Rigatoni	10 min. **
Spaghetti, vermicelli	8 min. **
Spaghetti, regular	8 min. **

D. STEAMING TIPS - LOBSTER - CRAB - SHRIMP

(1) Live Lobster and Crabs

- a. Live lobsters and crabs are steamed according to the time on the Suggested Timer Setting Guide.
- b. Steam them on a perforated pan with a catch pan (a solid pan) on a lower pan slide. Discard the juices and non-edible matter collected during steaming.

(2) Lobster Tail 8 oz.

- a. To serve in a shell, cut the frozen lobster tail in half, lengthwise. Place the cut side up on a perforated pan. Steam 5-6 minutes or until the meat turns opaque white. Season and garnish to serve.
- b. To serve a butterfly lobster tail, thaw tail, cut top shell length-wise all the way to the tail fins. Spread shells apart and pull meat out. Close empty shell and lay meat on top of shell. Steam according to Suggested Timer Setting Guide.

For volume preparation:

20 to 25. 6-8 oz. Lobster tails can be steamed on one 12 x 20 x 1 perforated pan.

(3) King Crab Legs

- a. Available as cooked and frozen. Steam just long enough to heat through.
- b. Served either whole or cut into 3 sections.
- c. Suggested Timer Settings 4 minutes
12 lb of sectioned legs per 12 x 20 x 2 ½ perforated pan
10 lb of whole legs per 12 x 20 x 2 ½ perforated pan

(4) Shrimp

- a. Shrimp are available as:
Green shrimp in frozen 5 lb. blocks
Peeled, deveined and ready to cook
Peeled, deveined and cooked
- b. Shrimp is very delicate seafood. When over cooked it becomes very rubbery, therefore, it is better to slightly under cook the shrimp rather than over cook it. Refer to Suggested Timer Setting Guide for cooking shrimp for various sizes.

SECTION 8: LIMITED WARRANTY

CLEVELAND RANGE products are warranted to the original purchaser to be free from defects in materials and workmanship under normal use and service for the standard warranty period of one year from date of installation or 18 months from date of shipment, whichever comes first.

CLEVELAND RANGE agrees to repair or replace, at its option, f.o.b. factory, any part which proves to be defective due to defects in material or workmanship during the warranty period, providing the equipment has been unaltered, and has been PROPERLY INSTALLED, MAINTAINED, AND OPERATED IN ACCORDANCE WITH THE CLEVELAND RANGE OWNER'S MANUAL.

CLEVELAND RANGE agrees to pay any FACTORY AUTHORIZED EQUIPMENT SERVICE AGENCY (within the continental United States, and Hawaii) for reasonable labor required to repair or replace, at our option, f.o.b. factory, any part which proves to be defective due to defects in material or workmanship, during the labor warranty period. This warranty includes travel time not to exceed two hours and mileage not to exceed 50 miles (100 miles round-trip), BUT DOES NOT INCLUDE POST START-UP, TIGHTENING LOOSE FITTINGS, MINOR ADJUSTMENTS, MAINTENANCE, CLEANING OR DESCALING.

The standard labor warranty allows factory payments of reasonable labor required to repair or replace such defective parts. Cleveland Range will not reimburse the expense of labor required to repair or replacement of parts after the standard warranty period, unless an Extended Labor Warranty Contract has been purchased to cover the equipment for the balance of the warranty period from the date of equipment installation, start-up, or demonstration.

PROPER INSTALLATION IS THE RESPONSIBILITY OF THE DEALER, THE OWNER-USER, OR INSTALLING CONTRACTOR, AND IS NOT COVERED BY THIS WARRANTY. Many local codes exist, and it is the responsibility of the owner and installer to comply with these codes. Cleveland Range equipment is built to comply with applicable standards for manufactures, including UL, A.G.A., NSF, ASME/Ntl. Bd., CSA, CGA, ETL, and others.

Boiler (Steam Generator) MAINTENANCE IS THE RESPONSIBILITY OF THE OWNER-USER AND IS NOT COVERED BY THIS WARRANTY. The use of good quality feed water is the responsibility of the Owner-User (see Water Quality Recommendations below). THE USE OF POOR QUALITY FEED WATER WILL VOID EQUIPMENT WARRANTIES. Boiler maintenance supplies, including boiler hand gaskets, are not warranted beyond the first 90 days after the date the equipment is placed into service. Preventive maintenance records must be available showing descaling per the applicable Cleveland Operators Manual for Boiler Proration Program considerations.

WATER QUALITY RECOMMENDATIONS

TOTAL DISSOLVED SOLIDS	Less than 60 parts per million
TOTAL ALKALINITY	Less than 20 parts per million
SILICA	Less than 13 parts per million
CHLORIDE	Less than 30 parts per million
pH factor	Greater than 7.5

The foregoing shall constitute the sole and exclusive remedy of original purchaser and the full liability of Cleveland Range for any breach of warranty. THE FOREGOING IS EXCLUSIVE AND IN LIEU OF ALL OTHER WARRANTIES, WHETHER WRITTEN, ORAL, OR IMPLIED, INCLUDING ANY WARRANTY OF PERFORMANCE, MERCHANTABILITY, OR FITNESS FOR PURPOSE, AND SUPERSEDES AND EXCLUDES ANY ORAL WARRANTIES OR REPRESENTATIONS, OR WRITTEN WARRANTIES OR REPRESENTATIONS, NOT EXPRESSLY DESIGNATED IN WRITING AS A "WARRANTY" OR "GUARANTEE" OF CLEVELAND RANGE MADE OR IMPLIED IN ANY MANUAL, LITERATURE, ADVERTISING BROCHURE OR OTHER MATERIALS.

CLEVELAND RANGE'S liability on any claim of any kind, including negligence, with respect to the goods or services covered hereunder, shall in no case exceed the price of the goods or services, or part thereof, which gives rise to the claim. IN NO EVENT SHALL CLEVELAND RANGE BE LIABLE FOR SPECIAL, INCIDENTAL, OR CONSEQUENTIAL DAMAGES, OR ANY DAMAGES IN THE NATURE OF PENALTIES.

LIMITED EXTENDED WARRANTY COVERAGE

The purchase of a Limited Extended Warranty Contract extends the standard warranty coverage to the purchased period of time (one to two years) from the date of installation, start-up, or demonstration, whichever is sooner.

An additional two years Parts and Labor Warranty can be purchased with each piece of Cleveland equipment for an additional 2% of the List Price per year. The 2% of list price charge will be the net invoice amount for each year of extended warranty purchased.

- Extended warranty must be purchased at the same time the equipment is purchased.
- Extended Warranty has the same exclusions as stated in our standard warranty.